

QUICK START GUIDE

Yealink **T33G**



Welcome to Intermedia Unite

WHAT'S IN THE BOX?

Yealink T33G

- | | | | |
|----|----------------|----|--------------------------|
| A. | Phone | E. | Stand |
| B. | Handset | F. | Guide |
| C. | Handset Cord | G. | Power Adapter (Optional) |
| D. | Ethernet Cable | | |

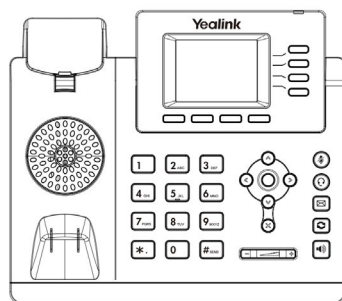

A.

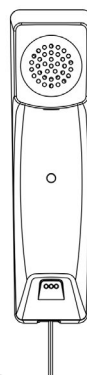

B.

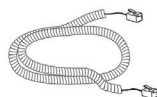

C.



D.



E.



F.

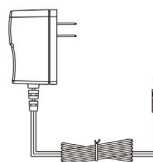

G.

GUIDED SETUP

Assembling Your Phone

Slot the stand into the correct interface to support the desired viewing angle, as shown below.

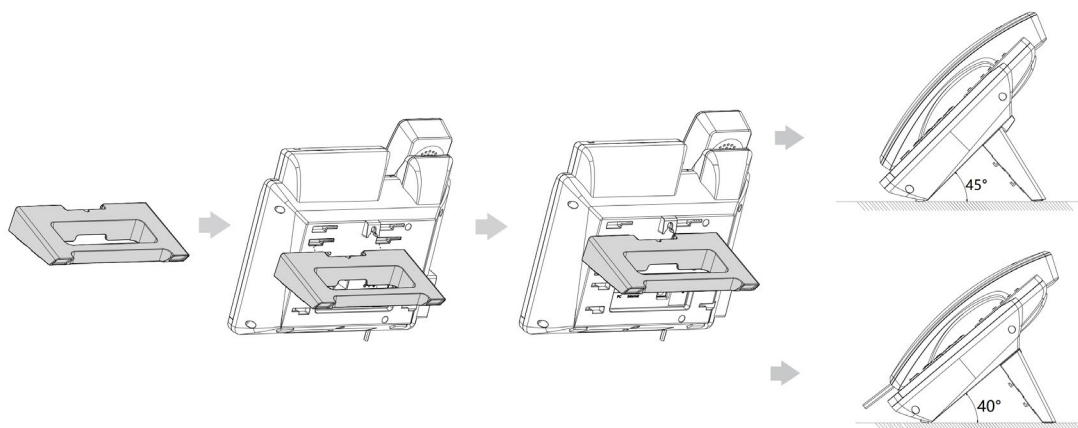

Connect Handset and Optional Headset

Note: Your phone supports headsets using a RJ9 cable.

For connection directions, refer to your headset documentation.

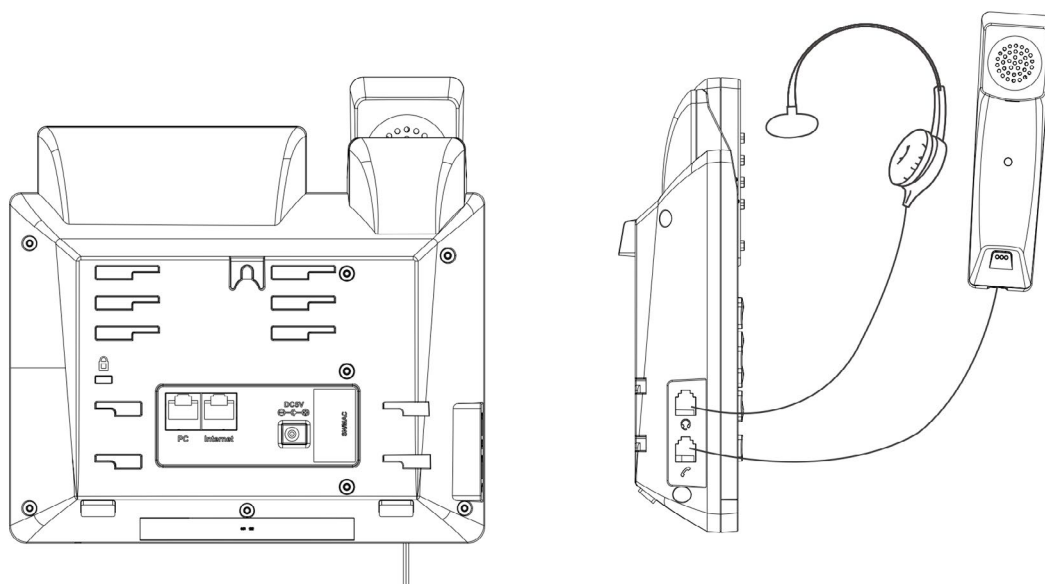

CONNECT CABLES

Please follow the diagram below to install your phone.

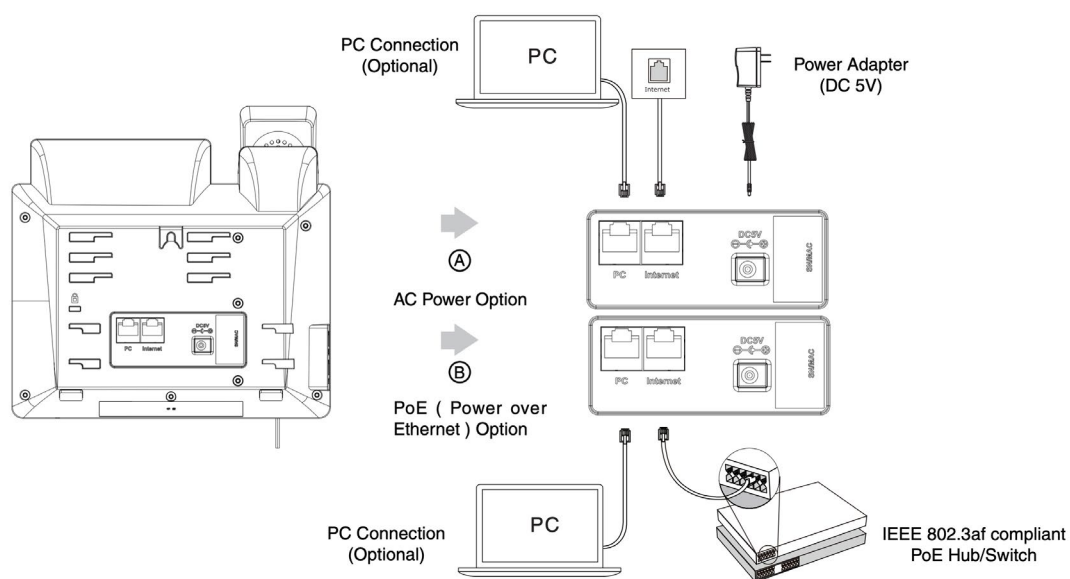

Once plugged into power & establishing a network connection, the phone will automatically download its configuration files & become usable. The voicemail box will be functional with a default greeting.

VOICEMAIL BOX SETUP

Recording Your Personal Voicemail Greeting

1. Press the "Messages" button. 
2. Enter the PIN provided to you by your Administrator, followed by the # key.
3. Select option 3 for personal options.
4. Select option 1 to record your voicemail greeting.
5. Follow the voice prompts to record and check your greeting.

Changing Your PIN From the Phone

1. Press the "Messages" button. 
2. Enter the PIN provided to you by your Administrator, followed by the # key.
3. Select option 3 for personal options.
4. Select option 2 to change your PIN.
5. Follow the voice prompts to record and check your greeting.

COMMONLY USED FEATURES

Placing Outgoing Calls

When the phone is not in use:

1. Pick up the handset or press the "Speakerphone" button. 
2. Dial tone will be heard.

When using a headset:

1. Press the "Headset" button  to activate headset mode.
2. No dial tone will be heard; Dial an extension or telephone number.

When you are already on a call:

1. Press the "Hold" soft key.
2. Press the "New Call" soft key.
3. Dial an extension or telephone number.
4. Resume the original call by pressing the "Resume" soft key.

Answering an Incoming Call

On the handset:

- Pick up the handset to answer the call.

On a headset:

- When the headset is connected, press the "Headset" button  to answer the call.

On Speakerphone:

- Press the "Speaker" button  to answer the call.

Rejecting an Incoming Call

Press the “Reject” soft key to immediately send the caller to voicemail.

Ignoring an Incoming Call

Press the “Silence” soft key to ignore the incoming phone call.

Note: The caller will continue to hear ringing for the specified amount of time, defined in the phone’s “No Answer Forwarding” settings.

Ending a Call

On a handset

- Hang up the handset or press the “More” soft key followed by the “EndCall” soft key.

On a headset:

- Press the “More” soft. Key, followed by the “End Call” soft key.

On speakerphone:

- Press the “Speakerphone” button.

Hold



Placing a call on hold:

- While on a call, press the “Hold” soft key.

Retrieving calls on hold:

- Press the “Resume” soft key.

Mute

1. To mute the microphone on a call, press the “Mute” button. 
2. To un-mute the microphone, press the “Mute” button again. 

Voicemail

1. Press the “Envelope” button. 
2. Enter your PIN when prompted, followed by a #.

Transferring Calls

Blind Transfer

1. Press the Trans soft key during an active call.
2. Enter the number you want to transfer to.
3. Press the B Trans soft key.

Semi-Attended Transfer

1. Press the Trans soft key during an active call.
2. Enter the number you want to transfer to, and press the Send soft key.
3. Press the Trans soft key when you hear the ring-back tone.

Attended Transfer

1. Press the Trans soft key during an active call.
2. Enter the number you want to transfer to, and press the Send soft key.
3. Press the Trans soft key when the second party answers.

Call Waiting

While already on a call, and a new call rings in, you will hear a beep tone emitted by your phone.

To Answer the Second Call:

1. Press the “Answer” soft key to access that call. The first call will be placed on hold.
2. Once the second call has ended, resume the original call by pressing the “Resume” soft key.

To Reject the Second Call:

- Press the “Reject” soft key to immediately send the caller to voicemail.

Volume Adjustment

In-Call Volume:

- While on a call, press the “+” and “-” buttons  to raise or lower the volume.

Ringer Volume:

- While the phone is not in use, press the “+” or “-” buttons  to adjust the ringer volume on the phone.

Speakerphone

While the phone is not in use:

- Press the “Speakerphone” button  to activate the speakerphone and get dial tone for an outbound call.

While on a call on the handset or headset:

- Press the “Speakerphone” button  to continue the current call on the speakerphone.

While a call on speakerphone is active:

- Press the “Speakerphone” button  to hang up the current call.

Forwarding Calls



1. Press the “Menu” soft key.
2. Press the right arrow key to highlight “Features” and press the “Ok” button.
3. Press the “Ok” button while highlighting “Call Forward”.
4. Press the “Ok” button or the “Enter” soft key.
5. If “Always Forward” is currently disabled, “Always Forward: Off” will be displayed.
6. Press the “Ok” button, followed by the left or right “Arrow” button to enable always forwarding. Next press the down “Arrow” button and enter a phone number, then press the “Save” soft key.”
7. Enter a valid telephone number or extension.
8. Press the “Ok” button or the “Save” soft key.

Disabling “Always Forward”:

1. If “Always Forward” is currently enabled, “Always Forward: On” will be displayed.
2. Press the “Ok” button or the “Enter” soft key.
3. Use the left or right “Arrow” button to disable always forwarding.
4. Press the “Ok” button or the “Save” soft key.

“Busy Forward” and “No Answer Forward” can be set in a similar manner.

Redial

- Press  to enter the Placed Calls list, select the desired entry, and press  or the Send soft key.
- Press  twice when the phone is idle to dial out the last dialed number.



We are here to help

Online: www.intermedia.net/knowledgebase/voice

Email: voicesupport@intermedia.com

Call: 1.877.880.0055



Intermedia has been recognized by J.D. Power for providing “An Outstanding Customer Service Experience” for its Assisted Technical Support. J.D. Power 2021 Certified Assisted Technical Program, developed in conjunction with TSIA. Based on successful completion of an audit and exceeding a customer satisfaction benchmark for assisted support operations. For more information, visit www.jdpower.com or www.tsia.com.

Questions? Contact Us Today.